



WITTENSTEIN

cyber motor

## cyber<sup>®</sup> simco<sup>®</sup> drive SIM2050D

Operating Manual





## Revision history

Revision	Date	Comment	Chapter
01	02.03.2017	New version	All
02	23.03.2017	WCM	All
03	05.12.2017	Support hotline Risk assessment SERCOS III STO	All 10
04	04.06.2019	Translation ja	All
05	18.08.2020	Identification plate, Code, Gen 2	All
06	10.03.2021	Maximun screw depth	5.7.1

## Technical support

Should you have any questions about customer service or repair, please contact our Customer Service department.

### **Customer Service department WITTENSTEIN cyber motor GmbH**

Walter-Wittenstein-Str. 1  
D-97999 Igersheim, Germany

Tel.: +49 (0) 79 31 / 493-15900  
Fax: +49 (0) 79 31 / 493-10903

E-mail: [service@wittenstein-cyber-motor.de](mailto:service@wittenstein-cyber-motor.de)

Should you have any questions about installation, startup, or optimization, please contact our support hotline.

### **WITTENSTEIN cyber motor GmbH support hotline**

Tel.: +49 (0) 79 31 / 493-14800

## Copyright

© WITTENSTEIN cyber motor GmbH 2021

This documentation is copyright protected.

WITTENSTEIN cyber motor GmbH reserves all the rights to photo-mechanical reproduction, copying, and the distribution by special processes (such as computers, file media, data networks), even in parts.

Subject to technical and content changes without notice.

## Contents

<b>1</b>	<b>About this manual</b>	<b>3</b>			
1.1	Signal words	3			
1.2	Safety symbols	3			
1.3	Design of the safety instructions	4			
1.4	Information symbols	4			
<b>2</b>	<b>Safety</b>	<b>4</b>			
2.1	Approvals	4			
2.1.1	CE conformity	4			
2.1.2	Safety conformity (STO) in accordance with the Machinery Directive	5			
2.2	EC directives	5			
2.3	Startup	5			
2.4	Hazards	5			
2.5	Personnel	5			
2.6	Intended use	6			
2.7	Improper use	6			
2.8	Risks	6			
2.8.1	Prohibited movements	6			
2.8.2	Dangerous temperatures	6			
<b>3</b>	<b>Description of the cyber® simco® drive</b>	<b>7</b>			
3.1	Identification of the drive amplifier	7			
3.2	Code	8			
3.3	Electrical data	8			
3.4	Description of the cyber® simco® drive series	9			
3.4.1	Integrated safety	9			
3.4.2	Digital control	9			
3.4.3	Inputs and outputs	9			
3.4.4	Ambient conditions	9			
3.5	Requirements for cables and wiring	9			
3.6	STO safety function	10			
<b>4</b>	<b>Transport and storage</b>	<b>10</b>			
4.1	Transport	10			
4.2	Packaging	10			
4.3	Storage	10			
<b>5</b>	<b>Mechanical installation</b>	<b>10</b>			
5.1	Safety instructions	10			
5.2	Dimensions	11			
5.3	Mounting options	11			
5.4	Installation space	12			
5.5	Environmental conditions for vibration/shock	12			
5.6	Mounting position	12			
5.7	Heat dissipation	12			
5.7.1	SIM2050D flex cooling unit	13			
5.8	Ventilation/cooling	13			
<b>6</b>	<b>Electrical installation</b>	<b>14</b>			
6.1	Safety instructions	14			
6.2	Requirements for power adapters and supply voltage	14			
6.3	Overview of plug connections	15			
6.4	Connection diagram	16			
6.5	Grounding and functional ground	17			
6.6	Shield connection	17			
6.7	Electrical interfaces	17			
6.7.1	X1/X2: Fieldbus interface CANopen	17			
6.7.2	X1/X2: Fieldbus interface PROFINET / EtherNet/IP, PROFINET, EtherNet/IP, SERCOS III	18			
6.7.3	X3: RS232	18			
6.7.4	X4: Encoder	19			
6.7.5	X5: Resolver	20			
6.7.6	X6: Digital I/O	20			
6.7.7	X7: Motor connection	21			
6.7.8	X8: Power supply	22			
6.8	Fuses	22			
6.9	Motor circuit protection	23			
<b>7</b>	<b>Startup and operation</b>	<b>23</b>			
7.1	Safety instructions	23			
7.2	Startup software	23			
7.2.1	Displays on the device	24			
7.2.2	LED P1 status drive	24			
7.2.3	LED P2 drive fault state	25			
7.2.4	LED P3 fieldbus status	25			
7.2.5	LED P4 fieldbus fault state	26			
<b>8</b>	<b>Maintenance and disposal</b>	<b>28</b>			
8.1	Maintenance	28			
8.2	Repairs	28			
8.3	Disposal	28			
<b>9</b>	<b>Attachment</b>	<b>28</b>			
9.1	Tightening torques	28			
<b>10</b>	<b>Instructions for STO safety function</b>	<b>28</b>			
10.1	Installation space	28			
10.2	STO wiring	29			
10.3	Important information for STO	29			
10.4	Intended use of STO	29			
10.5	Improper use of STO	29			
10.6	Technical specifications and STO pin assignment	30			
10.7	STO pin assignment	30			
10.8	Function description	31			
10.8.1	Safe operation sequence	32			
10.9	Functional check	32			

# 1 About this manual





This manual contains necessary information to safely use the cyber® simco® drive amplifier, hereinafter referred to as the drive amplifier.  
 The operator must ensure that this operating manual is read through by all persons assigned to install, operate, or maintain the drive amplifier, and that they fully comprehend them.  
 Store these instructions within reach of the drive amplifier.  
 Pass the safety instructions on to other persons as well.  
 The original manual was created in German; all other language versions are translations of these instructions.

## 1.1 Signal words

The following signal words are used to indicate possible hazards, prohibitions, and important information:

	<b>⚠ DANGER</b>
	<b>This signal word indicates an imminent danger that will cause serious injuries or even death.</b>
	<b>⚠ WARNING</b>
	<b>This signal word indicates a potential hazard that could cause serious injuries and even death.</b>
	<b>⚠ CAUTION</b>
	<b>This signal word indicates a potential hazard that could cause minor or serious injuries.</b>
	<b>NOTICE</b>
	<b>This signal word indicates a potential hazard that could lead to material damage.</b>
	<b>A note without a signal word indicates application hints or especially important information for handling the product.</b>

## 1.2 Safety symbols

			
General hazard	Hot surface	Electric voltage	Component sensitive to electrostatic discharge

### 1.3 Design of the safety instructions

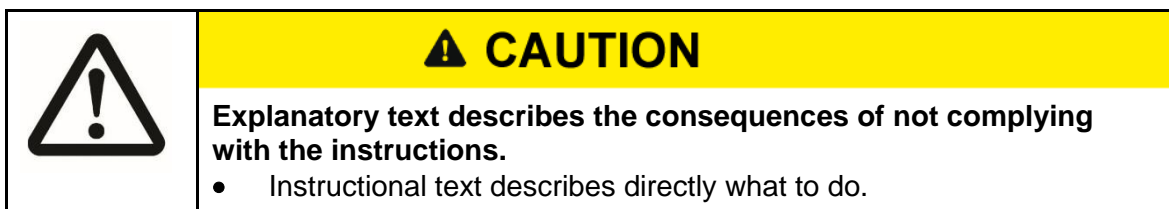

### 1.4 Information symbols

The following information symbols are used:

- Indicates an action to be performed
- ➡ Indicates the results of an action
- ⓘ Provides additional information about the action

## 2 Safety

This operating manual, especially the safety instructions, and the rules and regulations valid for the operating site must be observed by all persons working with the drive amplifier. In addition to the safety instructions in this manual, also observe any (legal and otherwise) applicable environmental and accident prevention rules and regulations (e.g. personal safety equipment).

### 2.1 Approvals

#### 2.1.1 CE conformity

The drive amplifier was tested in authorized testing laboratories in accordance with the requirements of this documentation. Deviations and nonconformity with requirements in this documentation mean that the drive amplifier may not fulfill statutory requirements under certain circumstances.

The drive amplifier is in conformity with the following directives:

- Machinery Directive (2006/42/EC)
- Electromagnetic Compatibility (EMC) (2014/30/EU)
- RoHS Directive (2011/65/EU)

In terms of interference immunity, the drive amplifier fulfills the requirement for the category "second environment" (industrial environment).

In the area of interference emission, the drive amplifier fulfills the requirements for category C3.

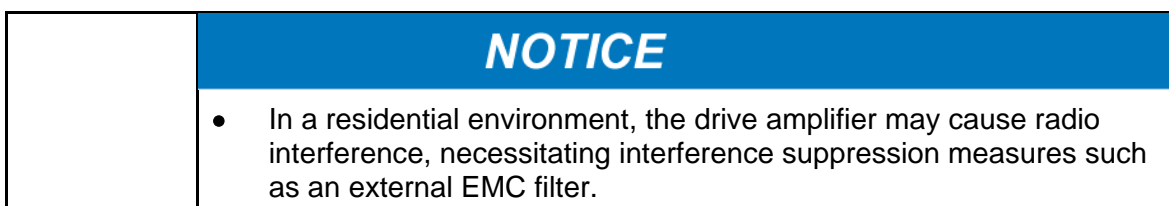

**2.1.2 Safety conformity (STO) in accordance with the Machinery Directive**

The drive amplifier provides a two-channel, functionally safe STO function (**Safe Torque Off**). The function disables the firing pulses of the power transistors so that the drive can be switched safely to torque OFF.

The circuit design has been tested and subsequently assessed by TÜV Süd. According to that assessment, the circuit design used for the "Safe Torque Off" safety function in the cyber® simco® drive series of drive amplifiers is suitable for meeting the requirements for SIL 3 in accordance with EN 61508 and category 4 PLe in accordance with EN ISO 13849-1:2015.

The subsystems (drive amplifiers) are fully described in terms of safety by the following characteristics:

Operating mode	EN 13849-1	EN 61508	PFH <sub>D</sub> [1/h]
Single-channel	PLd, cat 3	SIL 2	1E-10
Two-channel	PLe, cat 4	SIL 3	1E-10

**2.2 EC directives**

The drive amplifier is subject to the following EC directive:

- Machinery Directive (2006/42/EC)
- Electromagnetic Compatibility (EMC) (2014/30/EU)
- RoHS Directive (2011/65/EU)

Startup is prohibited within the scope of the EC directives until it has been determined that the machine/system in which this drive amplifier is installed corresponds to the regulations within these directives.

**2.3 Startup**

For installation in machines and systems, start of intended use of the drive amplifier is prohibited until it has been determined that the machine or system complies with the provisions of the EC Machinery Directive 2006/42/EC and the EC EMC Directive 2014/30/EU. For use in residential areas, additional EMC measures are necessary.

It is the responsibility of the manufacturer of the machine or system to ensure that the threshold values, as stipulated by the EMC regulations, are adhered to.

**2.4 Hazards**

The drive amplifier has been constructed according to current technological standards and accepted safety regulations.

- ⓘ To avoid danger to the operator or damage to the machine, the drive amplifier may be put to use only for its intended usage (see Chapter 2.6 "Intended use") and in a technically flawless and safe state.

**2.5 Personnel**

Only qualified technicians who have read and understood this manual may carry out work on the drive amplifier.

Information on the drive amplifier, in particular the safety instructions, must be accessible to all persons who work with the drive amplifier.

Qualified technicians are characterized by their education and training in the use of electronic drive technology. They know the relevant standards and accident prevention regulations for drive technology and can evaluate its use. Potential hazards are recognized immediately. The local regulations (ICE, VDE, VGB) are known to the technicians and are taken into account during their work.

In case of ambiguities and functions that are not described or not sufficiently described in the documentation, the manufacturer or retailer must be contacted.

## 2.6 Intended use

The drive amplifiers are intended for operation of permanent magnet EC synchronous servo motors with compatible feedback systems in stationary machines and systems.

Other uses must first be approved by the manufacturer.

Installation of the drive amplifiers is only approved in stationary electrical cabinets or stationary machine frames. They are used in industrial environments. For use in residential areas, additional EMC measures are necessary. The user must prepare a hazard analysis of the final product.

## 2.7 Improper use

The drive amplifiers are not suitable for operation of motors other than EC synchronous servo motors or motors with non-compatible feedback systems.

In addition, the following applications are excepted from intended use:

- Life-sustaining medical devices
- Applications in explosive areas
- Use in nuclear plants
- Use in airplanes

## 2.8 Risks

The manufacturer must strive to reduce residual risks associated with the drive amplifier as much as possible by taking appropriate action. Nonetheless, known residual risks must be taken into account for the risk assessment of machines and systems.

### 2.8.1 Prohibited movements

Prohibited movements can be caused by:

- The failure or shut-down of safety monitoring
- Software fault in associated controllers or bus systems
- Error during parameterization
- Wiring fault
- Limited reaction time of the controller
- Operation outside of the specifications
- Electromagnetic interference, lightning strike
- Component failure

### 2.8.2 Dangerous temperatures

Dangerous temperatures on the surface of the device can be caused by:

- Faulty installation
- Incorrect installation site
- Faulty electrical protection
- Conductive pollution, condensation



### 3 Description of the cyber® simco® drive

#### 3.1 Identification of the drive amplifier

The identification plate is fitted on the side or the front of the drive amplifier.

Designation		Designation	
A	Product designation	J	Permissible ambient temperature
B	Type code	K	Rated current $I_n$
C	Material number	L	Maximum current $I_{max}$
D	Customer material number	M	Intermediate circuit voltage $U_D$
E	Calendar week and year of production	N	PWM frequency
F	Serial number	O	Bus interface
G	Data-Matrix-Code (DMC)	P	Protection class
H	Flux-Code	Q	CE mark
I	Manufacturer		

Table 3.1: Identification plate (sample values)

### 3.2 Code

Using the following code, the properties of the drive amplifier can be determined.

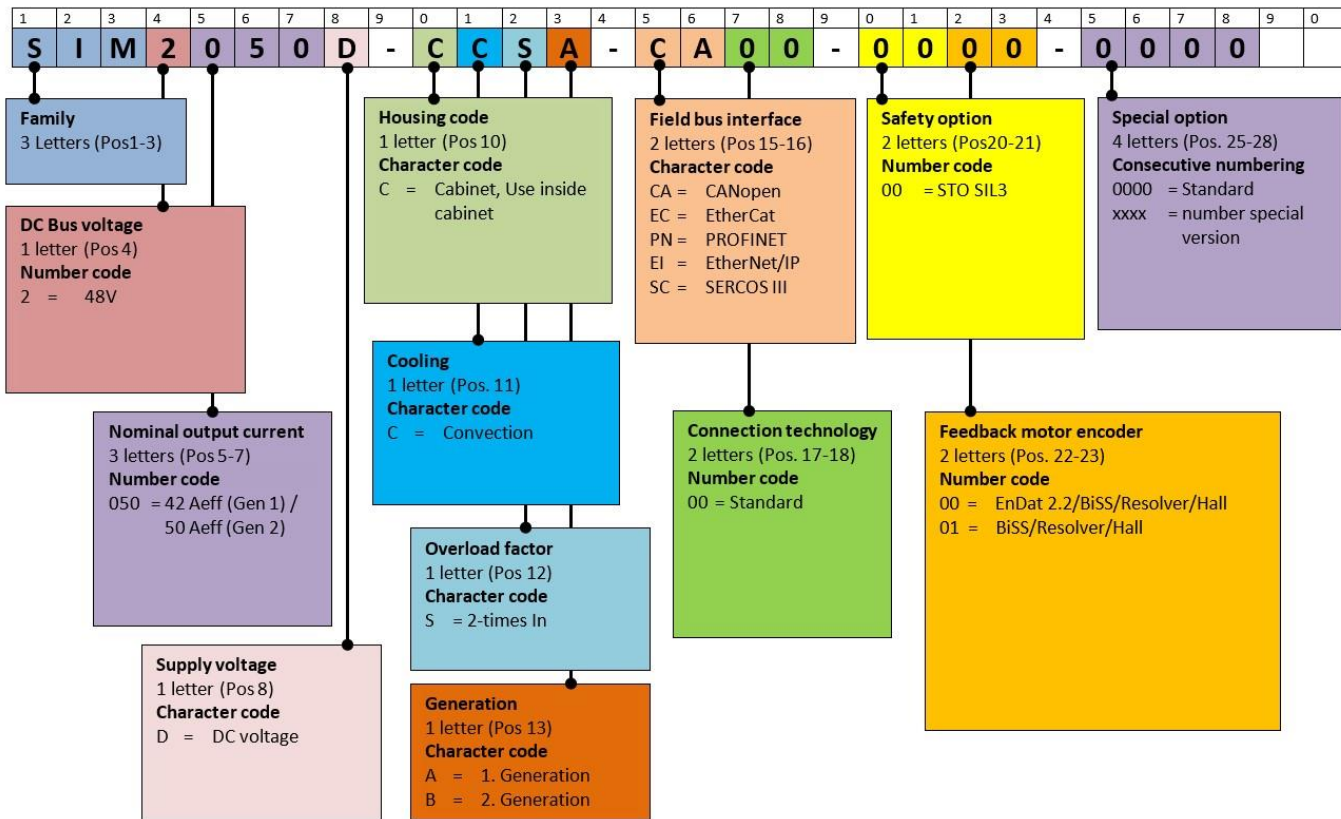

### 3.3 Electrical data

Electrical data	Unit	SIM2050D Gen 1	SIM2050D Gen 2
Nominal supply voltage, intermediate circuit	V DC	48	48
Nominal power	W	2000	2500
Intermediate voltage	V DC	12 .. 60	12 .. 60
Logic power supply	V DC	12 .. 60	12 .. 60
Current consumption of logic supply	mA DC	< 250	< 300
Nominal output current of the output stage	Aeff	42 <sup>1</sup>	50 <sup>1</sup>
Peak output current of the output stage (for 5s)	Aeff	84	100
Switching frequency of the output stage	kHz	8 .. 32	8 .. 32
Electrical rotary field frequency	Hz	0 .. 1000	0 .. 1000

<sup>1</sup> In the case of a vertical mounting position, the nominal output current of the output stage is achieved using the recommended cooling units and a PWM frequency of 8 kHz. The nominal output current may reduce considerably in the case of other mounting positions or PWM frequencies.

### 3.4 Description of the cyber<sup>®</sup> simco<sup>®</sup> drive series

WITTENSTEIN cyber<sup>®</sup> simco<sup>®</sup> drive is an intelligent drive amplifier series for sine-commutated servo motors with a continuous power of up to 2500 W and peak output of up to 5000 W. The different types of housing in the cyber<sup>®</sup> simco<sup>®</sup> drive series allow for a high degree of flexibility in installation.

The housing with protection class IP65 enables decentralized assembly, so that the drive technology can be integrated modularly and flexibly in the machine structure, reducing wiring. The drive amplifier with protection class IP20 on the other hand is designed for central installation in the control cabinet.

Depending on the device version, CANopen according to DS402, EtherCAT with CoE, PROFINET RT/IRT, Ethernet/IP IO or SERCOS III with FSP Drive is available as a communication interface.

The intelligence is reflected in the wide range of encoder interfaces, such as ENDAT 2.2, BISS C or Resolver, high resolution current regulation and event logging with real-time clock. Intuitive startup and diagnosis is possible using the PC-based, MotionGUI graphic user interface.

#### 3.4.1 Integrated safety

- Comprehensive diagnostic functions to protect the drive amplifier, such as overvoltage, overcurrent, short circuit or ground fault.
- Temperature monitoring of the drive amplifier, motor, and optionally the gearbox.

#### 3.4.2 Digital control

- Digital d-q current controller (PI) with a sampling rate of up to 32 kHz
- Digital position and speed controller (PI) with a sampling rate of 8 kHz
- Feed forward control of speed and current possible
- Adjustable pulse width modulation with a clock rate of 8 .. 32 kHz
- Anti-windup structure for all controllers

#### 3.4.3 Inputs and outputs

- 4 programmable galvanically isolated digital inputs, 24 V
- 2 programmable galvanically isolated digital outputs, 24 V (short-circuit proof)
- Output for controlling a 24 V holding brake

#### 3.4.4 Ambient conditions

- Ambient temperature during operation: 0 .. 45 °C for nominal data
- Air humidity during operation: Relative humidity < 85%, non-condensing
- Installation altitude: < 1000 m above sea level without affecting performance
- Protection class: IP20 in accordance with EN60529
- Degree of pollution 2 to EN 60204 / EN 50178

### 3.5 Requirements for cables and wiring

- In general, use high-quality, shielded motor and encoder cables to avoid EMC problems.

Wire type	Maximum length	Capacitance per unit length Core to shield
Motor wire	20 m	< 150 pF/m
Encoder line	20 m	< 120 pF/m
Resolver line	20 m	< 120 pF/m

### 3.6 STO safety function

The STO safety function (**Safe Torque Off**) is used for safe torque shutdown and to reliably protect drives from restarting. The drive amplifier is fitted with a two-channel STO function as standard in the basic model.

- ① Instructions for the STO safety function can be found in the appendix (see Chapter 110 "Instructions for STO safety function").

## 4 Transport and storage

### 4.1 Transport

- Transportation only in original packaging by qualified personnel
- Avoid hard impacts and vibrations
- Transport temperature: -20 .. 60 °C, max. 20 K/hour fluctuation
- Transport air humidity: Relative humidity max. 95%, non-condensing
- If the packaging is damaged, check the drive amplifier for visible damage. Contact the responsible shipping company.



**The drive amplifier contains components that are sensitive to electrostatic charge and can be damaged when handled improperly.**

- Ensure proper ESD handling by qualified personnel.

### 4.2 Packaging

- ESD-compatible box
- Identification: Label attached to the outside of the box

### 4.3 Storage

- Storage only in ESD-compatible original packaging
- Storage temperature: -20 .. 50 °C, max. 20 K/hour fluctuation
- Air humidity: Relative humidity max. 95%, non-condensing

## 5 Mechanical installation

### 5.1 Safety instructions

- For the mechanical installation, the ESD instructions must be observed.
- The drive amplifier (control cabinet version) must be protected from fog, water and penetration of metallic dust in the electrical cabinet.
- The drive amplifier must be checked for mechanical damage before installation. Only install flawless drive amplifiers.
- During installation in an electrical cabinet, sufficient ventilation must be provided.
- The operation of drive amplifiers exposed to condensation is not permitted.



### **⚠ CAUTION**

- Installation may only be performed in a de-energized state!
- Systems that are electrically connected must be properly secured so they cannot be switched back on and warning signs must be put up. Assembly may only be performed by trained personnel.

## 5.2 Dimensions

Mechanical specifications	
Weight [kg]	1,03
Height without plug [mm]	56,4
Width without plug [mm]	171
Depth without plug [mm]	158,25

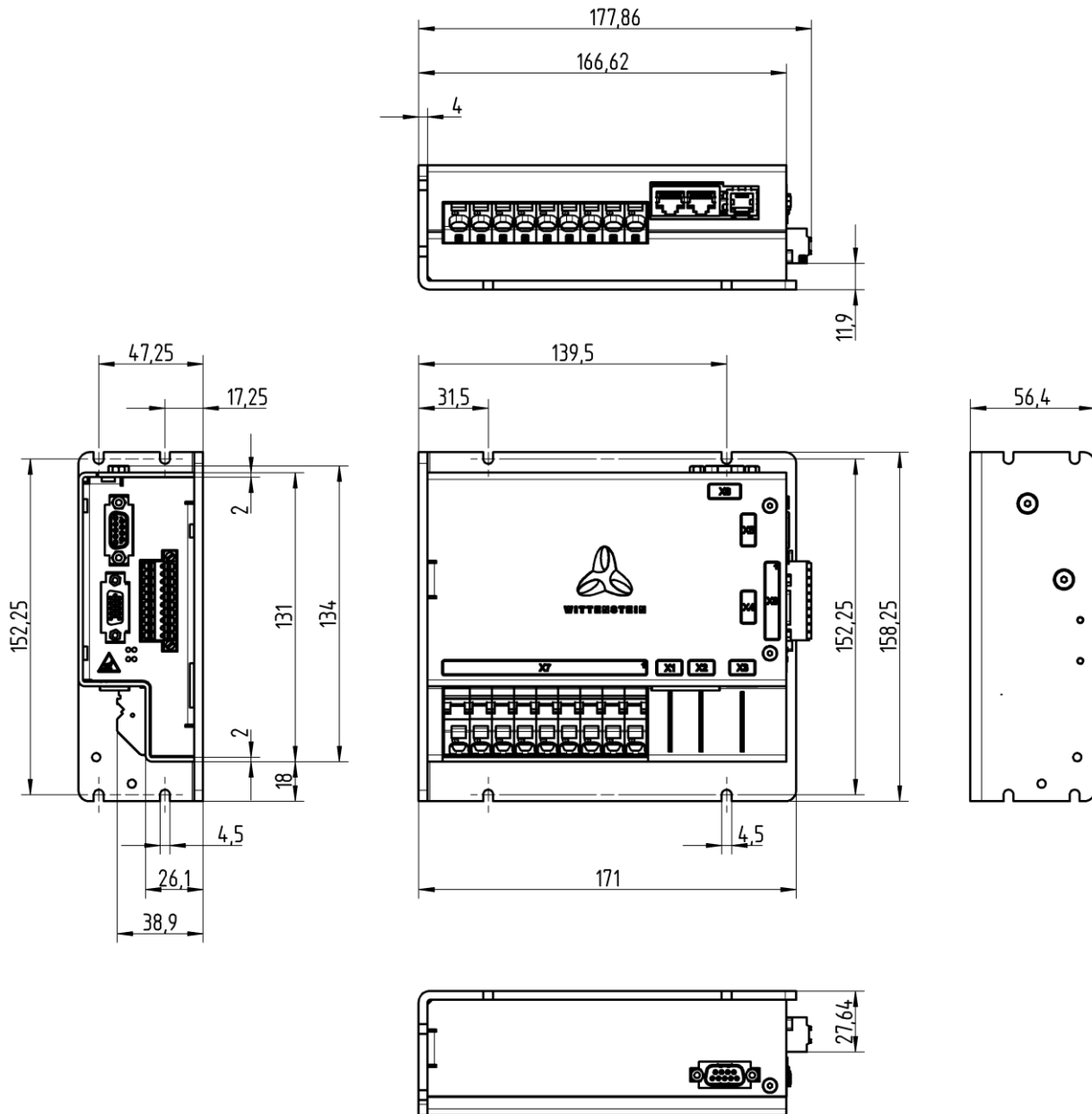

## 5.3 Mounting options

The drive amplifier is mounted to the mounting plate using a screw connection.  
 Mounting material: 4 cylinder head screws with hexagon socket ISO 4762 - M 4 – 8.8  
 Required tool: Hexagon socket size 3

## 5.4 Installation space

The drive amplifier is designed for installation in a control cabinet or closed installation space.

## 5.5 Environmental conditions for vibration/shock

The drive amplifier fulfills the following specifications:

- Vibration according to DIN EN 60068-2-6:2008
  - Frequency range 10 Hz – 150 Hz
  - Acceleration: 5 g
- Shock according to DIN EN 60068-2-27:2010
  - Shock form: Semi-sinusoidal
  - Acceleration: 50 g
  - Duration of the shock: 11 ms

## 5.6 Mounting position

The drive amplifier can be installed in any mounting position.

A vertical mounting position with a cooling unit should be used to achieve optimum heat dissipation.

Performance will decrease if the drive amplifier is not in vertical mounting position, or if the converter is used with insufficient cooling.

A minimum distance must be ensured if several drive amplifiers are mounted side by side. Please consult the Application department of Wittenstein cyber motor GmbH regarding the design of the heat dissipation concept.

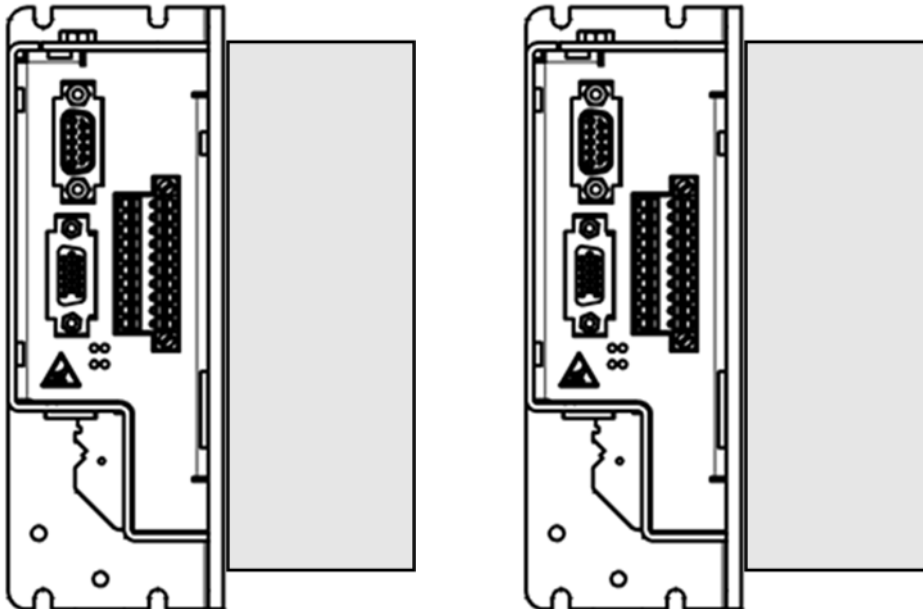

## 5.7 Heat dissipation

The SIM2050D cooling unit should be used for heat dissipation. It is available as an accessory. Only this cooling unit and a proper mounting position will ensure that the nominal continuous current of the output stage can be reached and that the device will not overheat.

Other types of heat dissipation can be coordinated with the Application department of WITTENSTEIN cyber motor GmbH.

### 5.7.1 SIM2050D flex cooling unit

Wittenstein material number 50017170-00-0.

The SIM2050D cooling unit consists of the cooling body and the M4x14 screws required for attachment to the device (see Chapter 9.1 „Tightening torques“). Different sets of mounting holes ensure that the the cooling unit can be rotated by 90° and proper cooling is ensured for different mounting positions of the drive amplifier.

The drive amplifier can also be mounted with the cooling unit using the four M4 threads (A-A) at the cooling body.

	⚠ CAUTION
	<ul style="list-style-type: none"> <li>The drive amplifier will be damaged if longer screws are used.</li> </ul>

**The maximum screw depth at the device for mounting of the cooling unit is 5mm.**

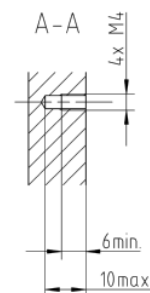
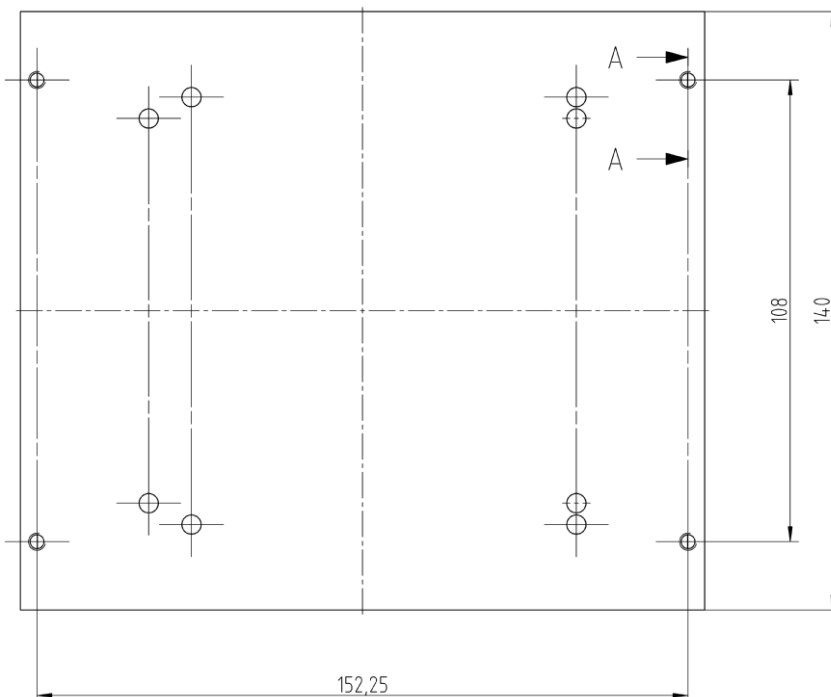
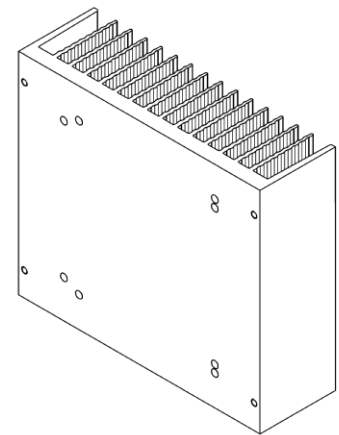
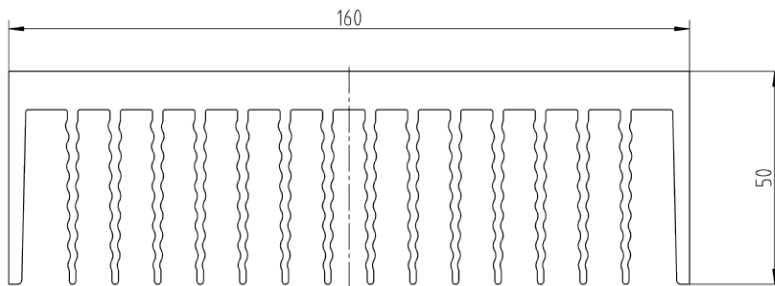

### 5.8 Ventilation/cooling

Ensure that there is sufficient forced air circulation in the closed control cabinet (convection).

## 6 Electrical installation

### 6.1 Safety instructions

- For the electrical installation, the ESD instructions must be observed.

	<h3>⚠ CAUTION</h3>
	<ul style="list-style-type: none"> <li>• Systems that are electrically connected must be properly secured so they cannot be switched back on and warning signs must be put up. Installation may only be performed by trained personnel.</li> <li>• Before startup, it must be checked that the wiring is correct and is free of mechanical damage. Only drive amplifiers with wiring in flawless condition may be put into operation.</li> <li>• Incorrect voltage, reverse polarity and nonconforming wiring can damage or destroy the drive amplifier.</li> <li>• Excessive or inadequate protection of the power supply can damage the cables or the drive amplifier.</li> </ul>

	<h3>⚠ CAUTION</h3>
	<ul style="list-style-type: none"> <li>• Observe the separate instructions for the STO safety function (see Chapter 3.6 "STO safety function")</li> </ul>

### 6.2 Requirements for power adapters and supply voltage

The drive amplifier's 24 VDC logic supply and 48 VDC power supply must be provided using power adapters or supply voltage sources with safe extra low voltage in SELV/PELV design to IEC 60950 / EN 60204. Power adapters or supply voltage sources having only basic installation are not permissible.

	<h3>⚠ DANGER</h3>
	<p><b>The use of unsuitable power adapters not in SELV/PELV design can lead to dangerously high voltages in the event of a fault, which could lead to dangerous electric shocks resulting in injuries or death.</b></p>

The drive amplifier can generate a voltage of up to 60 VDC at the power adapter terminals for power supply when operating as a generator. The power adapter should be designed for such operation. Otherwise suitable action must be taken to prevent feedback.



### 6.3 Overview of plug connections

The following illustration shows the arrangement of the plug connections with associated label on the drive amplifier:

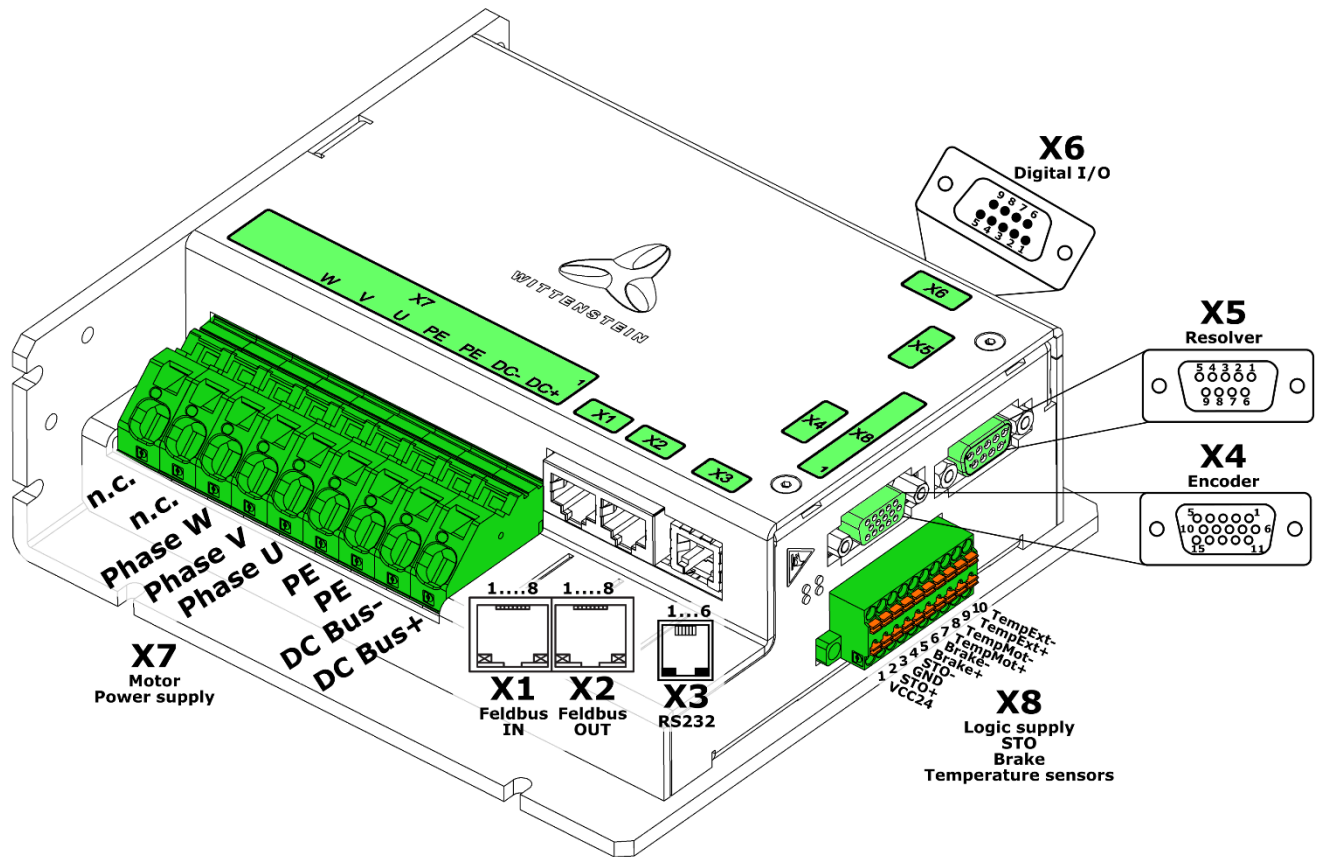

No.	Function	Connector type on the device	Connector type on the cable
X1	Fieldbus interface input	RJ45 socket	RJ45 plug
X2	Fieldbus interface output	RJ45 socket	RJ45 plug
X3	Diagnostic interface RS232	RJ12 socket	RJ12 plug
X4	Encoder interface	D-sub 15-pin female	D-sub 15-pin male
X5	Resolver interface	D-sub 9-pin female	D-sub 9-pin male
X6	Digital inputs/outputs	D-sub 9-pin female	D-sub 9-pin male
X7	Motor connection		
X8	Logic supply		

### 6.4 Connection diagram

The following illustration shows the principal connection diagram of the drive amplifier:

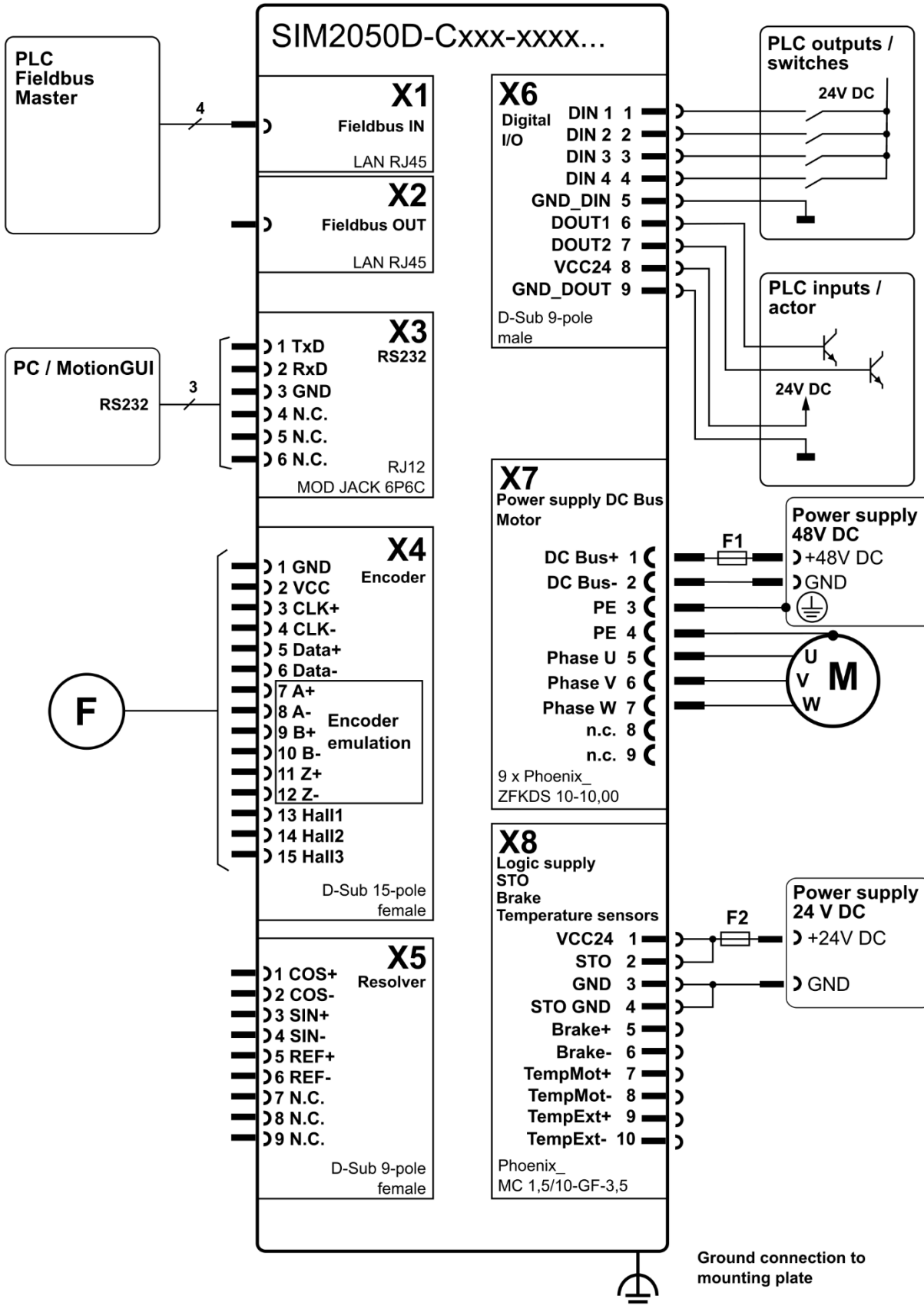

## 6.5 Grounding and functional ground

In order to maintain conformity with the EMC limit values and ensure the functioning of the drive amplifier the housing of the drive amplifier must be connected to the control cabinet or installation space's functional ground with low impedance.

<b>NOTICE</b>	
	<ul style="list-style-type: none"> <li>If the drive amplifier is not sufficiently grounded this may cause radio interference, leading to non-conformity with the EC EMC Directive. This can result in malfunctions in the drive amplifier and other electronic systems.</li> </ul>

## 6.6 Shield connection

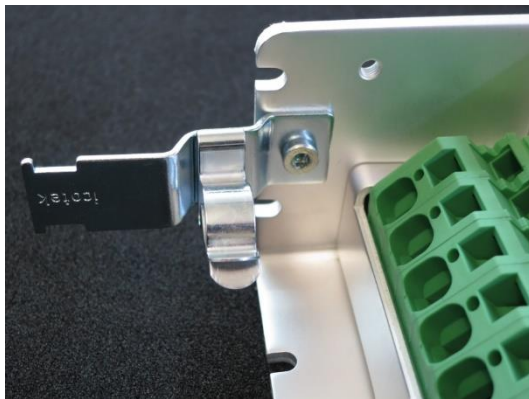

In order to maintain conformity with the EMC limit values and ensure the functioning of the drive amplifier the shielding of the motor cable must be connected to the housing of the drive amplifier with low impedance and over a large area.

This may be done using an LFZ/SKL 12-16 EMC shield clamp from Icotek, for example.

- ⓘ Tightening torques see chapter 9.1 „Tightening torques“.

## 6.7 Electrical interfaces

### 6.7.1 X1/X2: Fieldbus interface CANopen

- The CAN reference ground is identical with the logic reference ground.
- The CAN signals are galvanically isolated from the power of the drive amplifier.

Figure	Pin no.	Signal	Function
	J1	CAN_H	CAN High
	J2	CAN_L	CAN Low
	J3	CAN_GND	CAN reference ground
	J4	N.C.	
	J5	N.C.	
	J6	N.C.	
	J7	N.C.	
	J8	N.C.	

**Plug type on drive amplifier: LAN RJ45**

Connection	Properties	Unit	Minimum value	Nominal value	Maximum value
CAN	Baud rate	kbaud	100	500	1000

**6.7.2 X1/X2: Fieldbus interface PROFINET / EtherNet/IP, PROFINET, EtherNet/IP, SERCOS III**

- The signals are galvanically isolated from the logic and power of the drive.

Figure	Pin no.	Signal name	Function
	J1	RD+	Receive Data +
	J2	RD-	Receive Data -
	J3	TD+	Transmit Data +
	J4	N.C.	
	J5	N.C.	
	J6	TD-	Transmit Data -
	J7	N.C.	
	J8	N.C.	

**Plug type on drive amplifier: LAN RJ45**

Connection	Properties	Unit	Minimum value	Nominal value	Maximum value
RD / TD	Transmission speed	MBit/s		100	

**6.7.3 X3: RS232**

Figure	Pin no.	Signal	Function	Input/output
	1	TxD	Transmit Data	Output
	2	RxD	Receive Data	Input
	3	GND	Reference ground	
	4	N.C.		
	5	N.C.		
	6	N.C.		

**Plug type on drive amplifier: MOD JACK – MJLS 6P6C**

Connection	Properties	Unit	Minimum value	Nominal value	Maximum value
TxD / RxD	Baud rate	baud		115200	

**6.7.4 X4: Encoder**

- The plug may only be inserted when the drive amplifier is in a de-energized state.
  - Via the encoder interface X4, fully digital encoder systems with the protocols EnDat 2.2 and BISS C can be evaluated.
  - The encoder interface has a 5 V power supply, secured with a self-resetting fuse, with a max. current rating of 250 mA.
  - Encoder emulation is also available via encoder interface X4.

Figure	Pin no.	Signal name	Function	Input/output
	1	GND	Reference ground	Output
	2	VCC	Encoder power supply	Output
	3	CLOCK+	Clock output	Output
	4	CLOCK-	Clock output inverted	Output
	5	DATA+	Data channel	Input
	6	DATA-	Data channel inverted	Input
	7	A+	Encoder emulation A+	Output
	8	A-	Encoder emulation A-	Output
	9	B+	Encoder emulation B+	Output
	10	B-	Encoder emulation B-	Output
	11	Z+	Encoder emulation Z+	Output
	12	Z-	Encoder emulation Z-	Output
	13	Hall U	Hall sensor phase U	Input
	14	Hall V	Hall sensor phase V	Input
	15	Hall W	Hall sensor phase W	Input
<b>Plug type on drive amplifier: D-sub 15-pin female</b>				

Connection	Properties	Unit	Minimum value	Nominal value	Maximum value
<b>VCC</b>	Output voltage	V DC	4,5	5	5,5
	Output current	mA DC			250
<b>A+, A-, B+, B-, Z+, Z-</b>	Output voltage	V DC		5	
	Output current	mA DC		42	
	Output resistance	Ohm		120	

6.7.5 X5: Resolver

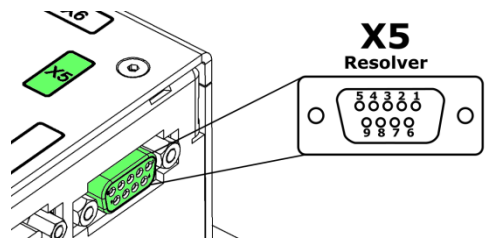
Figure	Pin no.	Signal name	Function	Input/output
	1	COS+	Cosine trace S1	Input
	2	COS-	Cosine trace S3	Input
	3	SIN+	Sine trace S2	Input
	4	SIN-	Sine trace S4	Input
	5	REF+	Reference trace R1	Output
	6	REF-	Reference trace R2	Output
	7	N.C.		
	8	N.C.		
	9	N.C.		
<b>Plug type on drive amplifier: D-sub 9-pin female</b>				

Connection	Properties	Unit	Minimum value	Nominal value	Maximum value
<b>Reference trace</b>	Excitation frequency	kHz		10	
	Output voltage	Vpk	4	5	5,5
	Output current	mA			30
<b>Sine/cosine</b>	Input resistance	kOhm		100	
	Input voltage	Vpk		2,5	5
	Resolution	Bit	10	12	14

6.7.6 X6: Digital I/O

- An external power supply must be connected to supply the digital outputs.
  - The digital outputs are galvanically isolated from the logic and power of the drive amplifier.
  - The digital outputs are short-circuit proof.

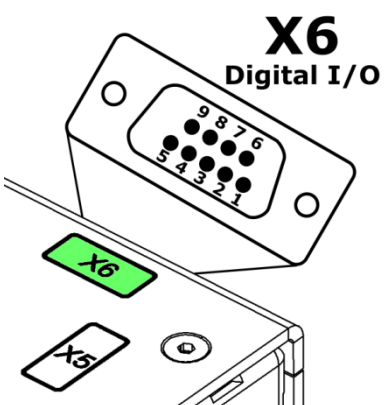
Figure	Pin no.	Signal	Function	Input/output
	1	DIN1	Digital input 1	Input
	2	DIN2	Digital input 2	Input
	3	DIN3	Digital input 3	Input
	4	DIN4	Digital input 4	Input
	5	GND	Reference ground	
	6	DOUT1	Digital output 1	Output
	7	DOUT2	Digital output 2	Output
	8	VCC24	Digital output supply	Input
	9	GND	Reference ground	
<b>Plug type on drive amplifier: D-sub 9-pin male</b>				

Connection	Properties	Unit	Minimum value	Nominal value	Maximum value
<b>DINx</b>	Input voltage	V DC	20	24	28
	Input current	mA DC	3	4	5
	Input resistance	kOhm		5,6	
	Sample time	msec			1
<b>GND</b>	Reference ground				
<b>DOUTx</b>	Output voltage	V DC	18	24	26
	Output current	mA DC			40
	Output resistance	kOhm	1	1,5	2
	Refresh rate	Hz			1
<b>VCC24</b>	Voltage	V DC	20	24	28
	Current	mA DC			80
<b>GND</b>					

**6.7.7 X7: Motor connection**

- The intermediate voltage DCBus - (pin 2) is not connected to the housing.

Figure	Terminal	Signal name	Function	Input/output
	1	DCBus+	Intermediate voltage +	Input
	2	DCBus-	Intermediate voltage -	Input
	3	PE	Earth conductor	
	4	PE	Earth conductor	
	5	PHASE_U	Motor phase U	Output
	6	PHASE_V	Motor phase V	Output
	7	PHASE_W	Motor phase W	Output
	8	N.C.		
	9	N.C.		

**Terminal on device: 9x Phoenix ZFKDS 10-10.00**  
**Usable wire types: Flexible wires with/without wire end ferrules, rigid wires**  
**Permissible wire cross-section: 0.2 – 16 mm<sup>2</sup> (with wire end ferrules 0.25 to 10 mm<sup>2</sup>)**  
**Stripping length: 12 mm**

Connection	Properties	Unit	Minimum value	Nominal value		Maximum value	
				Gen 1	Gen 2	Gen 1	Gen 2
<b>PHASE_x</b>	Current	Aeff		42	50	84	100
<b>DCBus+/-</b>	Voltage	V DC	12	48	48	60	60
	Current	A DC		42	50	84	100



**6.7.8 X8: Power supply**

- The logic supply is galvanically isolated from the intermediate voltage.
- The safety input STO is galvanically isolated from the intermediate voltage.

Figure	Pin no.	Signal name	Function	Input/output
<p><b>X8</b> Logic supply STO Brake Temperature sensors</p>	1	VCC24	Logic supply +24 VDC	Input
	2	STO	Safe Torque off input	Input
	3	GND	Logic reference ground	Input
	4	STO GND	STO reference ground	Input
	5	BRAKE+	Holding brake +	Output
	6	BRAKE-	Holding brake -	Output
	7	TempMot+	Motor temperature sensor +	Input
	8	TempMot-	Motor temperature sensor -	Input
	9	TempExt+	External temperature sensor +	Input
	10	TempExt-	External Temperature-sensor -	Input

Plug type on cable: TFMC 1.5/10-STF-3.5  
 Permissible wire cross-section: 0.25 .. 1.5 mm<sup>2</sup>  
 Stripping length: 10 mm

Connection	Properties	Unit	Minimum value	Nominal value	Maximum value
<b>VCC24</b>	Voltage	V DC	12	24	60
	Current @ 12V	mA DC			600
	Current @ 24V	mA DC			300
	Current @ 60V	mA DC			120
<b>STO</b>	Voltage	V DC	12	24	60
	Current	mA DC			120
<b>BRAKE+/-</b>	Voltage	V DC		24	
	Current	A DC			1,3

**6.8 Fuses**

- The power supplies are to be secured with the fuses specified in the table:

Fuses	
Logic supply (F2) X8 (pin 1 + 2)	Fuse or similar with max. 4 AT
Power supply (F1) X7 (pin 1)	Fuse or similar with max. 63 AT



## 6.9 Motor circuit protection

Circuit breaker hardware to protect the motor is not required as the motor is protected from overloading by an I<sup>2</sup>t function in the software and by an optional motor temperature sensor.

## 7 Startup and operation

### 7.1 Safety instructions

For secure application of the drive amplifier, the following regulations must be observed:

- Connection and operating instructions
- Local regulations
- EC regulations and the EC Machinery Directive

	<h3>⚠ CAUTION</h3>
	<ul style="list-style-type: none"> <li>• The housing temperature on the drive amplifier can reach 80 °C during operation.</li> <li>• Wait until the housing temperature has cooled down to 40 °C before touching the drive amplifier.</li> </ul>

	<h3>⚠ CAUTION</h3>
	<ul style="list-style-type: none"> <li>• Before startup, the machine manufacturer must prepare a risk assessment for the machine and take appropriate measures so that unforeseen movements cannot lead to personal injury or property damage.</li> </ul>

	<h3>⚠ CAUTION</h3>
	<ul style="list-style-type: none"> <li>• Only technicians with extensive experience with electrical and electronic systems and drive technology may start up the drive amplifier.</li> </ul>

### 7.2 Startup software

For parameterization and startup of the drive, the startup software *motion gui* is available as well as an interactive, html-based help.

The startup software *motion gui* is used to change and save the operating parameters of the drive amplifier. The connected drive amplifiers can be put into operation with the help of software.

In the html-based help, all parameters and the function of the drive amplifier are described.

	<h3>⚠ CAUTION</h3>
	<ul style="list-style-type: none"> <li>• Incorrect parameterization can cause uncontrolled movements. For this reason, never change parameters whose meaning you do not completely understand.</li> </ul>

**7.2.1 Displays on the device**

Four multicolor LEDs (P1-P4) are available on the drive amplifier for status and fault messages.

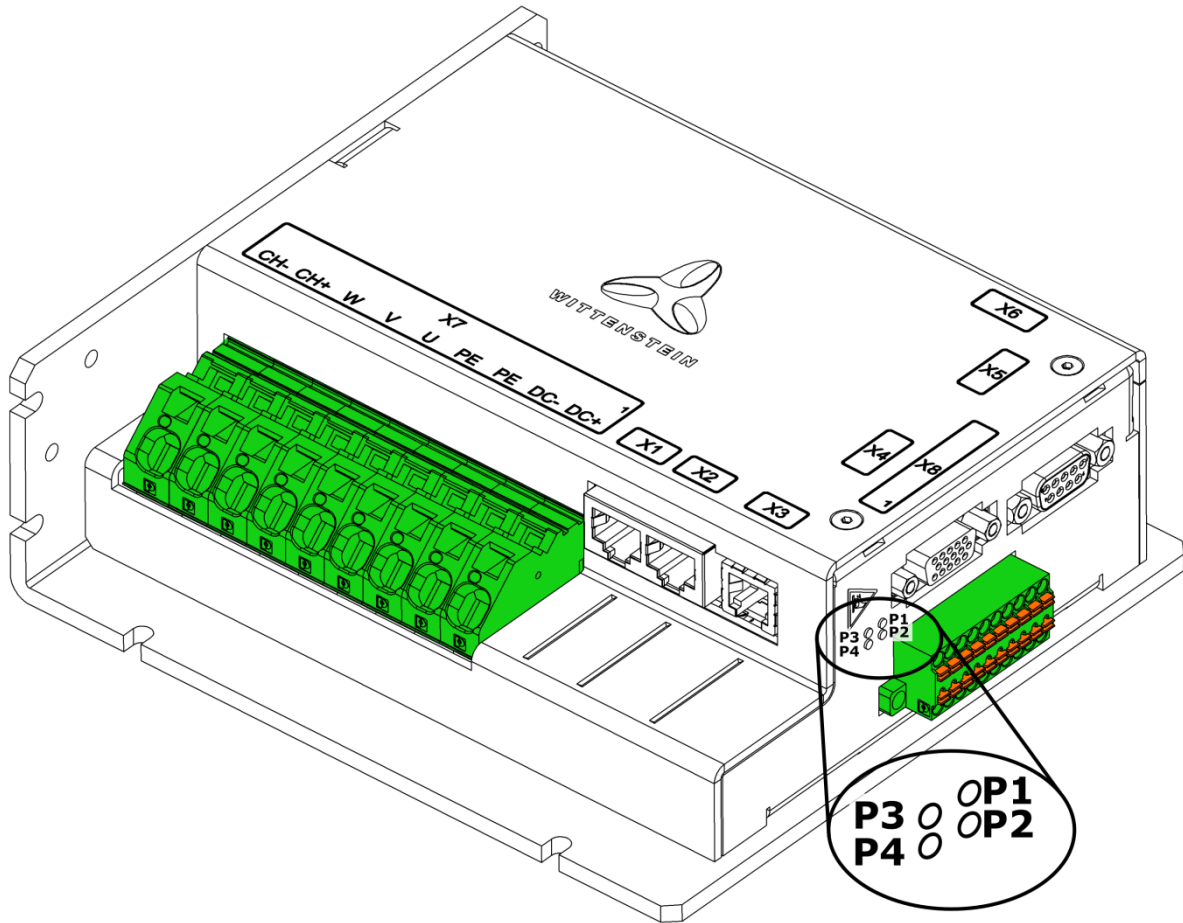



LED	Function
P1	Status of the drive (green)
P2	Fault state of the drive (red)
P3	Status of the fieldbus (green)
P4	Fault state of the fieldbus (red)

**7.2.2 LED P1 status drive**





Status LED	Meaning
Off	Drive amplifier has no power supply or is defective
Flashes green	Drive amplifier is in functional state and output stage disabled
Green	Drive amplifier is in functional state and output stage enabled

**7.2.3 LED P2 drive fault state**





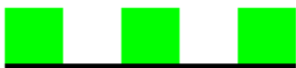

Status LED		Meaning
Off		Drive amplifier is in conforming state
Flashes red		Drive amplifier is in fault state, output stage disabled

**7.2.4 LED P3 fieldbus status**



CANopen:

Status LED		Meaning
Off		Drive amplifier has no power supply or is defective
Flashes green		The CAN node is in the status PRE-OPERATIONAL
Green		The CAN node is in the status OPERATIONAL



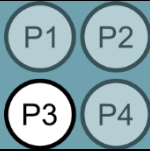

EtherCAT:

Status LED		Meaning
Off		Drive amplifier is in the status INIT
Flashes green (slowly)		The drive amplifier is in the status PRE-OPERATIONAL
Lights up green once		The drive amplifier is in the status SAFE-OPERATIONAL
Lights up green		The drive amplifier is in the status OPERATIONAL
Flashes green (rapidly)		Drive amplifier is in the status BOOTSTRAP



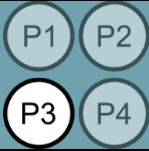

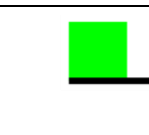
PROFINET:

Status LED		Meaning
Off		Profinet interface not ready
Green		Profinet interface is ready

Ethernet/IP:

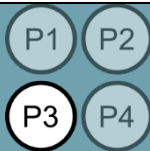

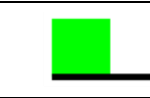
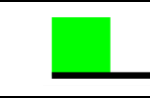
Status LED		Meaning
Off		Drive amplifier has no power supply or Ethernet IP interface not ready.
Flashes green		The Ethernet IP interface is ready for communication but does not have an active connection.
Green		The drive has not established an active Ethernet IP I/O connection.

SERCOS III:

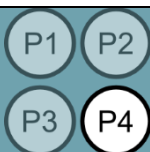
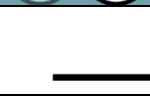

Status LED		Meaning
Off		No Sercos communication
Flashes green		Sercos communication is being established
Lights up green once		The drive amplifier is in the status SAFE-OPERATIONAL
Lights up green		Sercos phase 4 reached

7.2.5 LED P4 fieldbus fault state





CANopen:

Status LED		Meaning
Off		The CAN node is ready for operation
Red		The CAN node is in fault state

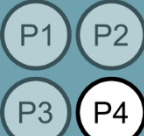

EtherCAT:

Status LED		Meaning
Off		The bus is ready for operation
Red		The bus is in fault state

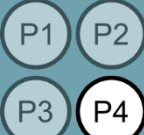

PROFINET:

Status LED		Meaning
Off		There is communication with a Profinet controller
Red		No connection available
Flashes red		Connection available however there is no active communication with an I/O controller

Ethernet/IP:

Status LED		Meaning
Off		There is communication with an Ethernet IP controller.
Flashes red		Connection timeout. A previously active connection has been interrupted.

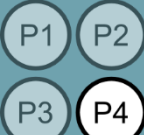
SERCOS III:

Status LED		Meaning
Off		The bus is ready for operation
Red		Sercos communication error or Sercos communication not yet established

## 8 Maintenance and disposal

### 8.1 Maintenance

The drive amplifiers are maintenance free. Opening the drive amplifier voids the warranty.

### 8.2 Repairs

The drive amplifier may only be repaired by the manufacturer. Opening the drive amplifiers voids the warranty and safety according to the specified standards is no longer ensured.

### 8.3 Disposal

In accordance with WEEE-2002/96/EC directive, we take back old equipment for proper disposal as long as the transport costs are paid by the sender.

## 9 Attachment

### 9.1 Tightening torques

Screw size	Max. tightening torque [Nm]	See chapter
M4	1.0	<ul style="list-style-type: none"> <li>– 5.7.1 „SIM2050D flex cooling unit“</li> <li>– 6.6 „Shield connection“</li> </ul>

## 10 Instructions for STO safety function

The STO safety function (**Safe Torque Off**) is used for safe torque shutdown and to reliably protect drives from restarting. The drive amplifier is fitted with a two-channel STO function as standard in the basic model.

Advantages of the STO safety function:

- Intermediate circuit and main circuit can remain active
- No contact wear because only control voltages are switched on and off
- Less wiring required
- Single-channel or two-channel control possible
- SIL 2 or SIL 3 systems possible

The STO safety function equates to stop category 0 (uncontrolled stoppage) defined by EN 60204-1. The STO safety function of the server amplifier can be triggered by external safety relays or by an external safety control with safe outputs.

The circuit design has been tested and subsequently assessed by TÜV. According to that assessment, the circuit design used for the "Safe Torque Off" safety function in the cyber® simco® drive series of drive amplifiers is suitable for meeting the requirements for SIL 3 in accordance with EN 61508 and category 4 PLe in accordance with EN ISO 13849-1:2015.

### 10.1 Installation space



A drive amplifier in IP20 design should be installed in a space that will ensure reliable operation of the drive amplifier.

The installation space must meet the requirements of protection class IP54 at least.

## 10.2 STO wiring

In the case of single-channel control, if the wiring for the STO signals is situated outside a control cabinet, it must be routed in a permanent installation and protected from external damage (e.g. by means of a cable duct or hard conduit). Further instructions for wiring can be found in the standard DIN EN 60204-1.

## 10.3 Important information for STO

	<p><b>⚠ CAUTION</b></p>
	<p><b>If the STO function is actuated during operation, the drive will coast to a stop in an uncontrolled manner and the drive amplifier reports the "Error_amp_sto_active" fault. Controlled braking of the drive will not be possible.</b></p> <ul style="list-style-type: none"> <li>• If an application requires controlled braking before the use of STO, the drive must first be braked under control and then the STO function must be triggered with a time delay.</li> </ul>
	<p><b>⚠ CAUTION</b></p>
	<p><b>Danger from short-term limited movements when STO function is activated.</b></p> <p>Simultaneous breakdown of two power transistors in the output stage can cause short-term movement up to 180° / pole pair number of the motor.</p> <ul style="list-style-type: none"> <li>• Make sure that a limited movement of this kind cannot cause any damage.</li> </ul>

## 10.4 Intended use of STO

The STO function is designed only for functionally safe switching of a drive to torque OFF and to prevent restarting. In order to achieve functional safety, the wiring of the safety circuit must meet the safety requirements of EN 60204, EN 12100, EN 61508 and/or EN 13849-1

## 10.5 Improper use of STO

The STO function must not be used if the drive needs to be stopped for the following reasons:

1. Cleaning, maintenance, or repair work; long interruptions in operation:  
In such cases the entire machine or system should be de-energized and secured (at the main switch).
2. Emergency stop situations:  
In emergency stop situations the power supply must be cut off by a line contactor (with emergency stop pushbutton).

### 10.6 Technical specifications and STO pin assignment

STO input	Data
STO inactive input voltage	12 .. 60 VDC
STO active input voltage	Open
Input current	15 to 120 mA
Response time (time between activation of STO function and motor being free of torque)	< 40 ms

### 10.7 STO pin assignment

SIL 2 / category 3 PLd:

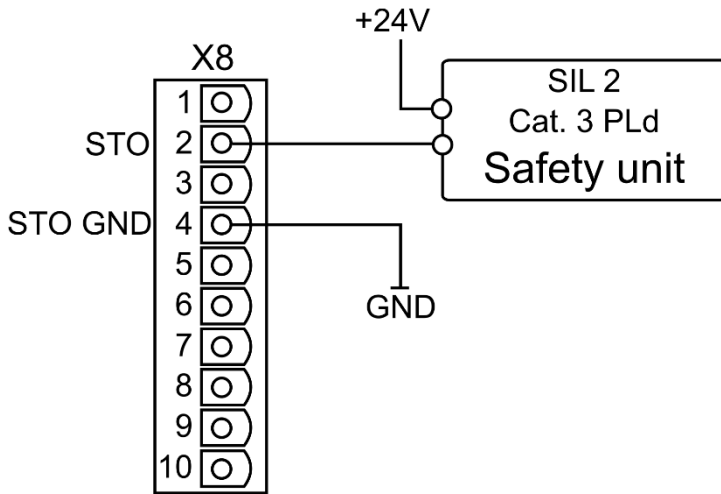

SIL 3 / category 4 PLe:

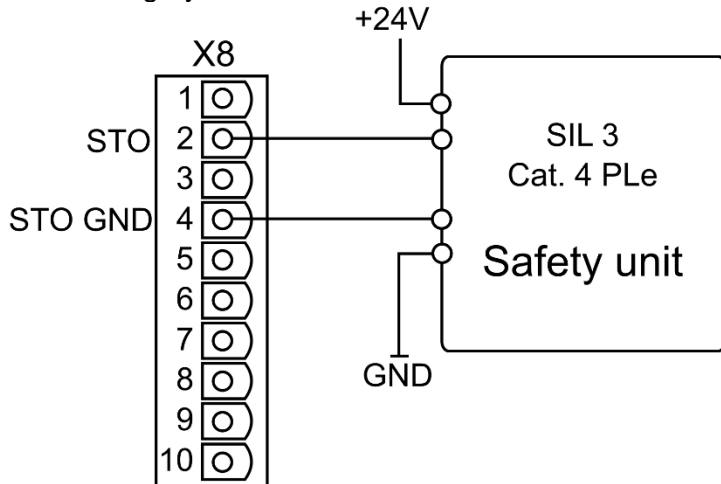



### 10.8 Function description

Use of the STO safety function requires the inputs STO and STO GND to be connected to the outputs of a safety control or safety relay that fulfills at least the requirements of PLd to EN 13849-1 or SIL 2 to EN 61508.

#### Single-channel control SIL 2 / PLd:

With single-channel control of the STO safety function, the STO input is switched on by an output of a safety relay. The STO GND is permanently connected to the GND of the safety relay.

STO +24 V status	STO GND status	Motor torque possible
Open	0 VDC	no
+24 VDC	0 VDC	yes

#### Two-channel control SIL 3 / PLe:

With two-channel control of the STO safety function, the STO and STO GND shutdowns are switched separately by two outputs of a safety control.

STO +24 V status	STO GND status	Motor torque possible
Open	Open	no
+24 VDC	0 VDC	yes

<b>NOTICE</b>	
	<ul style="list-style-type: none"> <li>When wiring the STO inputs inside an installation space, make sure that both the wiring used and the installation space itself meet the requirements of EN 60204-1.</li> <li>If the wiring is outside the installation space, it must be routed in a permanent installation and protected from external damage.</li> </ul>

<b>NOTICE</b>	
	<ul style="list-style-type: none"> <li>If the STO safety function is not required in an application, the STO input must be permanently connected directly to +24 VDC and the STO GND input must be permanently connected directly to GND. The STO function is thus shunted out and cannot be used. The drive amplifier is then no longer a safety component as defined by the Machinery Directive.</li> </ul>

### 10.8.1 Safe operation sequence

If an application requires controlled braking before the use of the STO function, the drive must be braked first and the STO function must be triggered with a time delay:

1. Controlled braking of drive
2. Once standstill is reached, disable the drive amplifier
3. In the case of a suspended load, mechanically lock the drive as well
4. Trigger STO

	<b>⚠ CAUTION</b>
	<p><b>The drive amplifier cannot hold the load with the STO function activated because the motor no longer supplies any torque. Risk of injury from suspended load.</b></p> <ul style="list-style-type: none"> <li>• Drives with a suspended load must be securely locked mechanically as well (e.g. with a suitable holding brake)</li> </ul>

	<b>⚠ CAUTION</b>
	<p><b>If the STO function is actuated during operation, the drive will coast to a stop in an uncontrolled manner. Controlled braking of the drive will not be possible. Danger from uncontrolled movement.</b></p>

### 10.9 Functional check

	<b>NOTICE</b>
	<ul style="list-style-type: none"> <li>• The STO function must be checked at initial startup, after any work on the system's wiring, and after replacing one or more components of the system.</li> </ul>

Steps to follow for a functional check:

1. Stop the drive. The drive amplifier remains enabled and under control.
2. Activate the STO function by triggering an emergency stop of the machine. The drive amplifier should enter its fault state and should issue the "ERROR\_AMP\_STO\_ACTIVE" fault.
3. Reset the fault using the "clear fault" function
4. Acknowledge the emergency stop and deactivate the STO function
5. Enable the drive and check that the drive is functioning



**WITTENSTEIN**

cyber motor

WITTENSTEIN cyber motor GmbH · Walter-Wittenstein-Straße 1 · 97999 Igersheim · Germany  
Tel. +49 7931 493-15800 · info@wittenstein-cyber-motor.de

WITTENSTEIN Inc. · 1249 Humbracht Circle · Bartlett, IL 60103 · USA  
Tel. +1 630 540 5300 · info@wittenstein-us.com

WITTENSTEIN S.P.A. · Via Giosuè Carducci 125 · 20099 Sesto San Giovanni MI · Italy  
Tel. +39 02 241357-1 · info@wittenstein.it

WITTENSTEIN Ternary Co., Ltd. · 99-5, Kosato · Ueda · Nagano · 386-0005 Japan  
Tel. +81 268 29 4620 · info-ternary@wittenstein-ternary.jp



**WITTENSTEIN – eins sein mit der Zukunft**

**[www.wittenstein-cyber-motor.de](http://www.wittenstein-cyber-motor.de)**